

MESO ∞ (Meso-infinity) Skincare Device User Manual

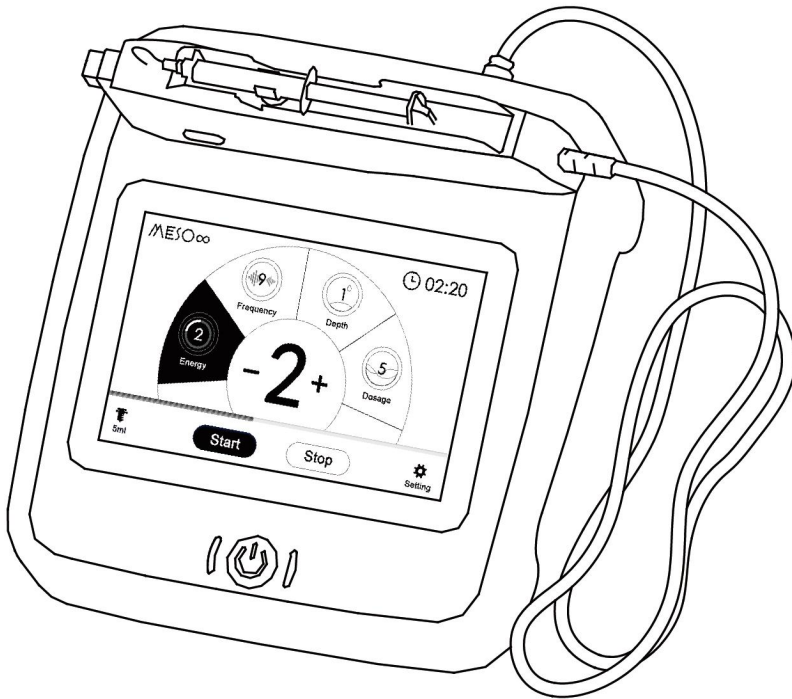

Contents

1. Safety instruction	1
1.1. Danger	1
1.2. Caution	1
1.3. Attention	1
2. Device Description	2
3. Product introduction	2
3.1. Host	2
3.2. Applicator	3
3.3. EO sterile cartridges	4
3.4. Operation interface	4
3.4.1. Boot animation	4
3.4.2. Welcome interface	5
3.4.3. Operation interface	5
3.4.4. Setting interface	6
3.5. Guidelines for use	7
4. Daily cleaning and maintenance	11
4.1. Host	11
4.2. Applicator	11
4.3. EO sterile cartridges	11
5. The common fault and solution	12
6. Technical Specification	13
7. Packing list	13
8. Warranty and after-sales service	14
9. Contact us	14

1. Safety instruction

Thank you for choosing our MESO[∞] Skincare Device.

Before use, please read all the safety and using instructions, it may occur danger or damage the device if violate it.

1.1. Danger

- Please be sure to unplug the plug from the socket before cleaning the device or applicator.
- Please do not put the device into water or other liquids; if the device accidentally falls into the water, please pull out the plug immediately, and do not directly touch the device dropped into the water.
- Please do not use the device in a humid, high temperature or high-electromagnetic environment.
- Please do not disassemble, refit or put the device into fire by yourself to avoid danger.
- Before use, please ensure that the system and its power supply are not obviously damaged. If the wires are damaged or the system is disassembled, do not use the device.

1.2. Caution

- This device can only be used with the supplied cord and power adapter.
- The power supply for this device is Class I type, Please ensure that the grounding port of the power supply socket is well grounded.
- Please turn off the device first and then pull out the power plug after use or before maintenance.
- This device must use our own EO cartridge, which is for single use only. Please ensure the cartridge is within the validity period and that the packaging is not damaged.
- Please keep the unused EO cartridges in cool and dry environment.
- Please do not use this device in the month, eyes, lips, breasts or genitals.

1.3. Attention

- The parameters of this device are recommended to be adjusted gradually from low to high.
- Do not use the instrument continuously for a long time in the same treatment area.
- Do not put the device in front of unattended children.
- Please install or unload the sterile cartridges accordance with the instructions of user manual.
- Please scrap the used sterile cartridges in time.

2. Device Description

- This introduction device is a fully automatic alloy penetration machine, which opens tens of thousands of micron-level channels in the epidermis. With ETM technology, it efficiently and quickly introduces nutrients into the dermis and activates skin cell metabolism, thereby improving skin quality, Moisturizing and firming effect. The import process is safe and painless, non-invasive and non-bleeding.

- This device is based on Linux platform, adopts high-precision motor, provides smooth running speed, high-quality interactive experience, precise output control, easy operation and convenient use.
- This device matches unique patented sterile cartridges, sterilization process, zero-based replacement, safety and hygiene. Matching 2 specifications of sterile cartridges can do facial and scalp care.

3. Product introduction

Product Name: MESO∞ Skincare Device

Model No.: TGME-A

3.1. Host

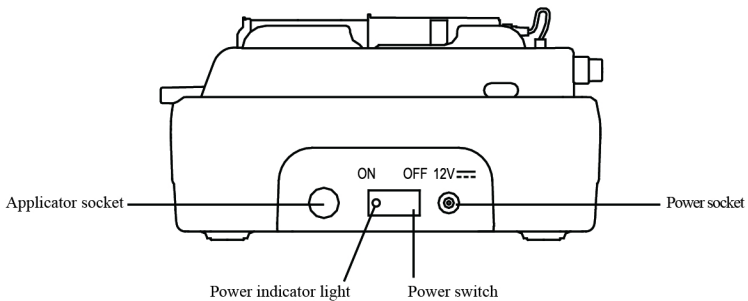
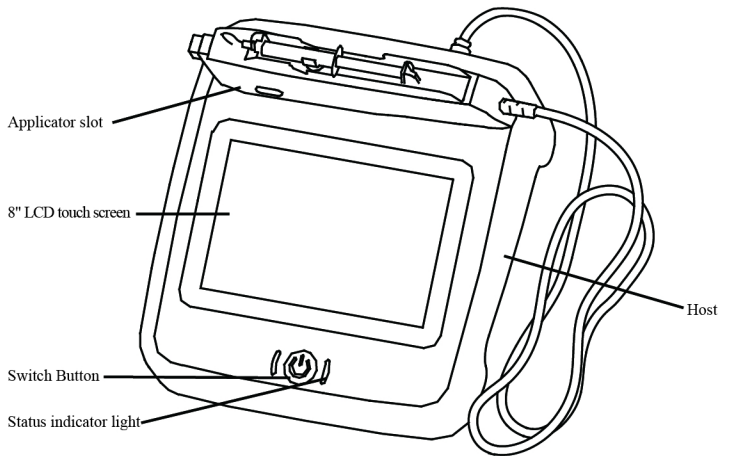

Introduction:

- Power socket: Used to connect the supplied power adapter.
- Power switch: The main power switch of the device, before connecting adaptor, please ensure power switch is off.
- Applicator socket: For connecting applicator, please note the direction, do not insert or pull out forcefully.
- Switch button: The device turn on/ turn off button is used to start the device or shut down device. In the “off” state, press and hold until the device emits a beep, and then release it to complete the start-up. In the “on” state, press the button shortly, the pop-up window "Are you sure to shut down?" will show up. This switch button has an indicator light, and the indicator light is on when the device is connected to the power supply and the main switch is turned on.
- Status indicator light: used to indicate the working status of the device. In "standby status", the indicator light flashes slow gradient; in "working status", the indicator light flashes fast gradient.

3.2. Applicator

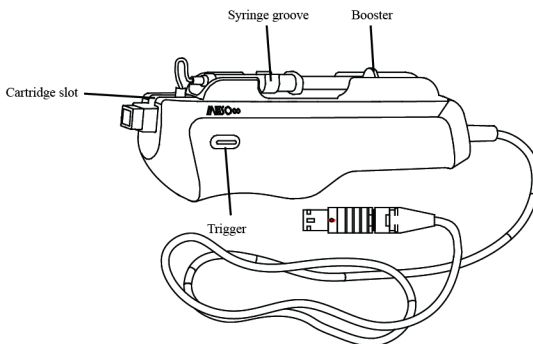

Introduction:

- Trigger: there are 2 triggers, which can be operated by pressing either trigger. For trigger usage, see following description.
- Syringe groove: Syringe groove can be used for 1ml, 2ml, 5ml and 10ml.

3.3. EO sterile cartridges

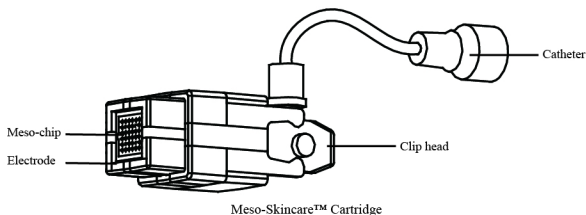

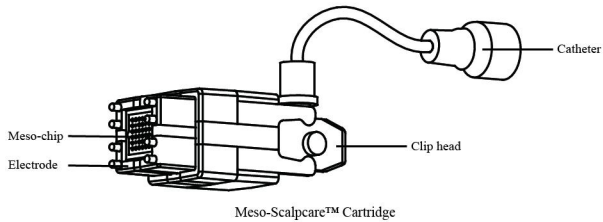

Instruction:

- EO Sterile cartridge has 32 microneedles and 5 micro channels, which can open skin channels and improve absorption of nutrients.
- ETM energy working on the skin by electrodes.
- The unique patented design is added to the scalp cartridge to avoid the obstacles of hair and directly fit the scalp.

3.4. Operation interface

3.4.1. Boot animation

After the device is turned on, it takes a period of time to start up. During this time, our logo and device animation will be displayed.



3.4.2. Welcome interface



Introduction:

- This is welcome interface, press “Entry” to enter operation interface.

- Software version number is showing on this interface.

3.4.3. Operation interface

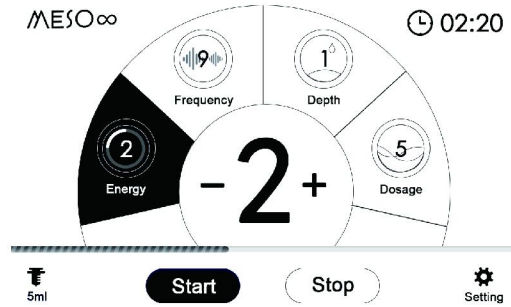

Introduction:

- Syringe: Choose the syringe, there are 1ml, 2ml, 5ml and 10 ml options. Under “Start” situation, syringe can not be choose.
- Energy: ETM output energy, the range is 0-5 level, ETM will have slight tingling feeling.
- Frequency: Set the cartridge frequency, the range is 1-10Hz.
- Depth: Adjust the intensity between the cartridge surface and skin, the range is 1-5 level.
- Dosage: The amount of liquid, the amount of liquid pushed out by cartridge per unit time, is divided into 0-5 level.
- Setting: Enter the setting interface, it cannot be operated under “Start” status during the treatment. It can be operated under “Stop” status.
- Start/stop: Start or Stop the treatment, the device runs according to the state of the trigger button after press the “Start” or “Stop” button.
- Running time: Record the operating time for one treatment.
- Progress bar: Show the current progress of the liquid solution in syringe.

3.4.4. Setting interface

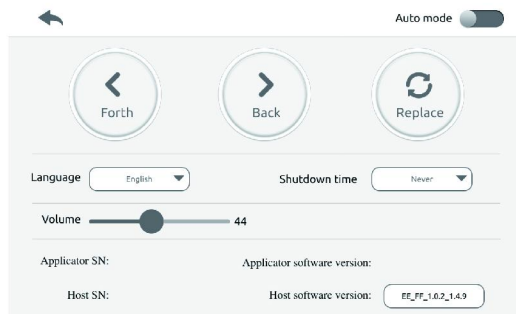

Introduction:

- Auto mode: Press the mode button to changing the operation mode between auto mode and manual mode.
 - A: Under the auto mode, click the trigger button once, and the applicator will switch between Running and Pause status.
 - B: Under the manual mode, keep pressing the trigger button will keep the applicator running, and the applicator will stop running when released.
- Forth/back: Adjust the position of the booster by pressing the trigger button.
- Replace: Press it for re-changing the liquid solution and cartridge.
- Language: Change to different language.
- Shutdown time: Adjust the auto shutdown time after no operating.
- Volume: Adjust the volume of sound.
- Version: The version number of the device.

3.5. Guidelines for use

1) Firstly, evaluate the basic physical condition of the client before the treatment, eliminate contraindications, and ensure that they can receive the treatment of this device.

- Contraindications :
 - Pregnant women ;
 - Patients with severe diseases such as Aids or syphilis ;
 - Patients with SLE, Scar diathesis or skin cancer ;
 - People with severe heart, liver, kidney and other internal organ diseases and malignant tumors ;
 - Patients with severe diabetes ;
 - Patients with the history of hypertension class II or above, heart disease, cerebral infarction or cerebral hemorrhage ;
 - Patients with open wounds or Patients have not completely healed by surgery ;
 - The treatment site with plastic filler ;
 - Patients with the pacemaker ;
 - Patients with epilepsy, mania and schizophrenia ;
 - (Scalp-care) Patients with psoriasis or scalp wound ;
 - (Scalp-care) Patients with fungal infection, e.g.: porrigo ;
 - (Scalp-care) Patients who is using the traditional Chinese medicine hair growth ;
 - (Scalp-care) Male patients who are taking medicines of finasteride, minoxidil.

2) Confirm that the applicator is well connected to the host machine.

3) Connect the power supply, turn on the power supply on the back of the host, and press the switch button of the front panel to start the machine. At this time, the applicator will perform an automatic calibration.

4) After entering the operation interface, select the corresponding syringe capacity, and the device will automatically push the booster to the setting position; and complete the reset of the cartridge slot.

5) Replace the syringe clip as needed size.

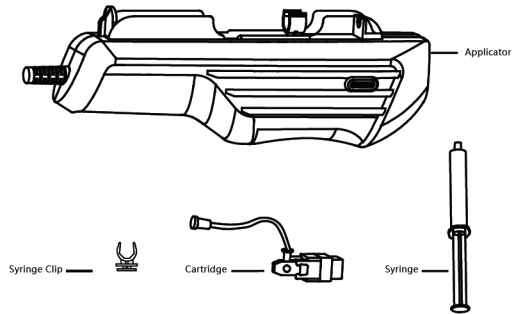

1-1

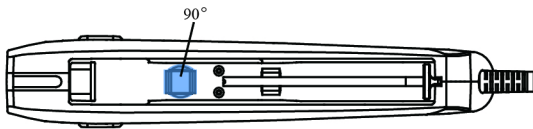

1-2

6) Use disposable sterile gloves to take out the sterilization cartridge, install the cartridge into the cartridge slot. After hearing two clicks, the cartridge is installed successfully.

- Note that the connecting pipe faces upward.
- Please do not touch the cartridge during the whole process! so as not to contaminate the cartridge.

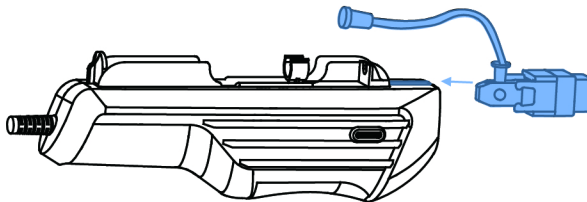

1-3

7) Connect one end of the connecting tube of the cartridge to the syringe, and then put the syringe into the syringe groove through the syringe clip.

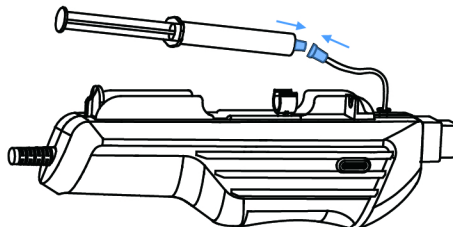

1-4

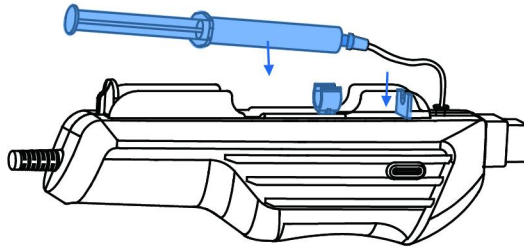

1-5

8) If there is a discrepancy between the booster position and the actual syringe position, you can enter the setting interface for minor adjustment.

- Choose "forth" or "back".
- Press the trigger button to adjust the corresponding operation.

9) Click "Start" to do the treatment. It can be adjusted the parameters during the treatment process.

10) After the treatment, click "Stop" to stop the device operation. It is recommended that the client should be used a sterile soothing spray or a sterile mask for facial caring.

11) Remove the cartridge and syringe, and scrapped. Wipe the handle surface and clean it completely by alcohol.

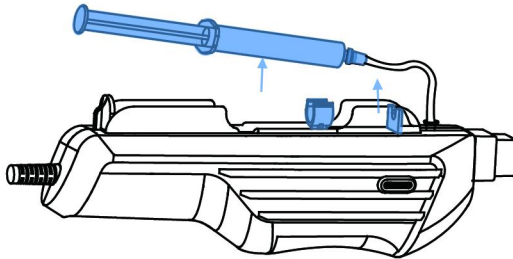

1-6

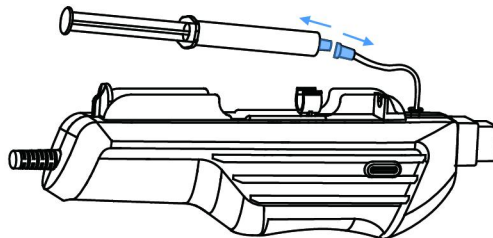

1-7

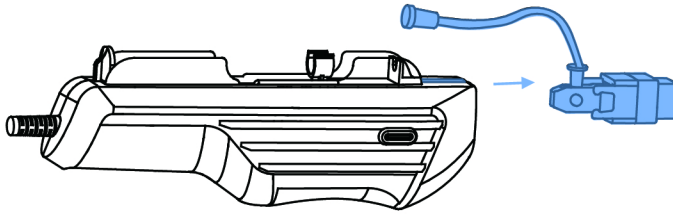

1-8

12) After using the device, press and hold the switch button to shut down.

13) If the device is not used for a long time, set the main switch at the back of the device to the "OFF" position.

Introduction:

1) Set Dosage to 0, which is the cavity mode.

2) The applicator must be plugged in and unplugged in the shutdown state. When the device is turned on, it is detected that the applicator is not connected, and a pop-up window will pop up. Please shut down and connect the applicator according to the prompts.

3) Running time reference in some configurations (continuous operation)

Syringe specifications	Dosage	Running Time
1 ml	1	25min
1 ml	5	5min
2 ml	1	25min
2 ml	5	5min
5 ml	1	50min
5 ml	5	10min
10 ml	1	50min
10 ml	5	10min

4. Daily cleaning and maintenance

4.1. Host

- Turn off the power, unplug the power cord and handle plug on the host.
- Clean the surface with a soft damp cloth.
- Do not clean the host in running water or other liquids.
- It only can be wiped with 75% alcohol. Do not use detergents, thinners, gasoline or other chemicals.
- Do not store the host in a place with high temperature, humidity or sun exposure.

4.2. Applicator

- You can clean the surface with a soft damp cloth as needed during use.
- After use, put the applicator back into the corresponding slot of the host.
- Not excessively bend or squeeze the applicator line.
- It is strictly forbidden to block the applicator slot with other objects.

4.3. EO sterile cartridges

- Store in a cool, dry and clean environment.
- After use, please dispose of it according to local scrap management regulations, and do not use it repeatedly.

5. The common fault and solution

Fault	Reason	Solution
When the host is not connected, the adapter indicator light is off.	1. Poor contact of the power cord or power adapter.	Check connection.
	2. The power cord or power adapter is damaged.	Replace.
The adapter indicator light is on, the device cannot be turned on.	1. Poor contact between power adapter and host.	Check connection (The main switch indicator light is on).
	2. The main switch is not turned on.	Turn on the main switch (the panel button switch indicator light is on at this time).
	3. Panel button switch failure.	Please Contact our after-sales department.
	4. The status indicator light is on and the screen is black.	Restart the device, if it still cannot be resolved, please contact our after-sales department..
Stay on the welcome interface, unable to enter the operation interface.	The host is not connected to the applicator.	
System breakdown. Unable to shut down. The touch screen cannot respond. Abnormal Noise .	System abnormal.	Restart the device, if it still cannot be resolved, please contact our after-sales department.

Note: If there are other failures not listed, please contact our after-sales department to solve it.

6. Technical Specification

Host Size	27cm×25cm×9cm
Applicator size	24cm×8cm×5cm
Package Size	43cm×32cm×15cm
Net weight	2.5KG
Gross weight	3KG
Rated Input	100~240V, 1.4A , 50/60Hz
Operating temperature	5°C~30°C
Operating humidity	20RH~80RH

Note: The device does not contain batteries.

7. Packing list

Number	Name	Quantity
1	Host	1pc
2	Applicator	1pc
3	User Manual	1pc
4	Adaptor	1pc
5	Power cable	1pc
6	Syringe clip-A	1pc
7	Syringe clip-B	1pc
8	Syringe clip-C	1pc
9	Syringe clip-D	1pc
10	Warranty card & Certificate of conformity	1pc

8. Warranty and after-sales service

- Within one year from the date of purchase, the company is responsible for free maintenance of the device quality problems caused by the material and workmanship of the instrument. The sterilization treatment head is not within the scope of free maintenance! Device failures caused by human negligence, environmental factors, accidents, alterations and improper maintenance are not included in the free repairs.
- If the device fails during start-up or normal operation, immediately shut down the system and contact our after-sales service department. Only personnel authorized by our company can maintain the device. Otherwise, we do not assume any responsibility.

9. Contact us

Address: Room2073, No.101, 1st-3rd Floor, Building1, No.13 Liye Road, Changping District, Beijing102206, China

Tel: +86-10-80703190

Email: service@thinkergauss.com

Website: www.thinkergauss.com



Thinkergauss Ltd.

 Tel: +86-10-80703190

 Website: www.thinkergauss.com

 Address: Room2073, No.101, 1st-3rd Floor, Building1, No.13 Liye Road, Changping District, Beijing102206, China