



microbeau

*spektra*  
**XION** S

Cartridge Machine

**USER MANUAL**



# INDEX

Safety Notice	3
Machine Overview	4
The Grip	5
The Body	6
The GiveKnob	7
Adjust the Give	8
Replacing the GiveKnob	9
The MotorBolt System	10
Changing the Stroke Wheel	11
Detaching the MotorBolt	12
RCA Connection	13
Connecting your Machine	14
Adjusting Needle Depth	15
Additional Information	16
Troubleshooting	17

**SAFETY NOTICE**

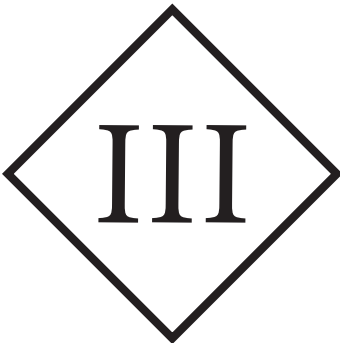

**CLASS III SYMBOL**

A Class III appliance is designed to be supplied from a separated/safety extra-low voltage (SELV) power source. The voltage from a SELV supply is low enough that under normal conditions a person can safely come into contact with it without risk of electrical shock. The extra safety features built into Class I and Class II appliances are therefore not required. For medical devices, compliance with Class III is not considered sufficient protection, and further more-stringent regulations apply to such equipment.

<b>TECHNICAL DATA</b>	
Operating Voltage:	4-9.5 V DC
Current:	.3 A
Stitch Frequency:	25 - 160 Hz
Stroke:	2.5 mm
Connection:	3.5 mm RCA connection
Drive:	Brush DC motor & drive
Operating Mode:	Continuous operation
Ambient Temperature:	+10 to +35 °C
Relative Humidity:	30 to 75%
Dimensions (Ø X L):	33 x 114 mm
Weight:	Approx. 137 g



**BARRIER PROTECTING YOUR MACHINE**

Although the grip is autoclavable, we strongly suggest the use of barrier products to protect your machine. For a visual demonstration of many barrier protection methods, please visit our YouTube channel at [YouTube.com/fkiron](https://www.youtube.com/fkiron).

"This machine is not to be used by persons (including children) with reduced physical, sensory or mental capabilities, or lack of experience and knowledge"

MACHINE OVERVIEW

# THE Spektra Xion S

## Changing Tattooing Forever

The first pen style machine providing artists full control of parameters that unleash their creative vision. Compatible with most power supplies on the market, the Spektra Xion S is a one tool solution for all your Micropigmentation (MP) needs.

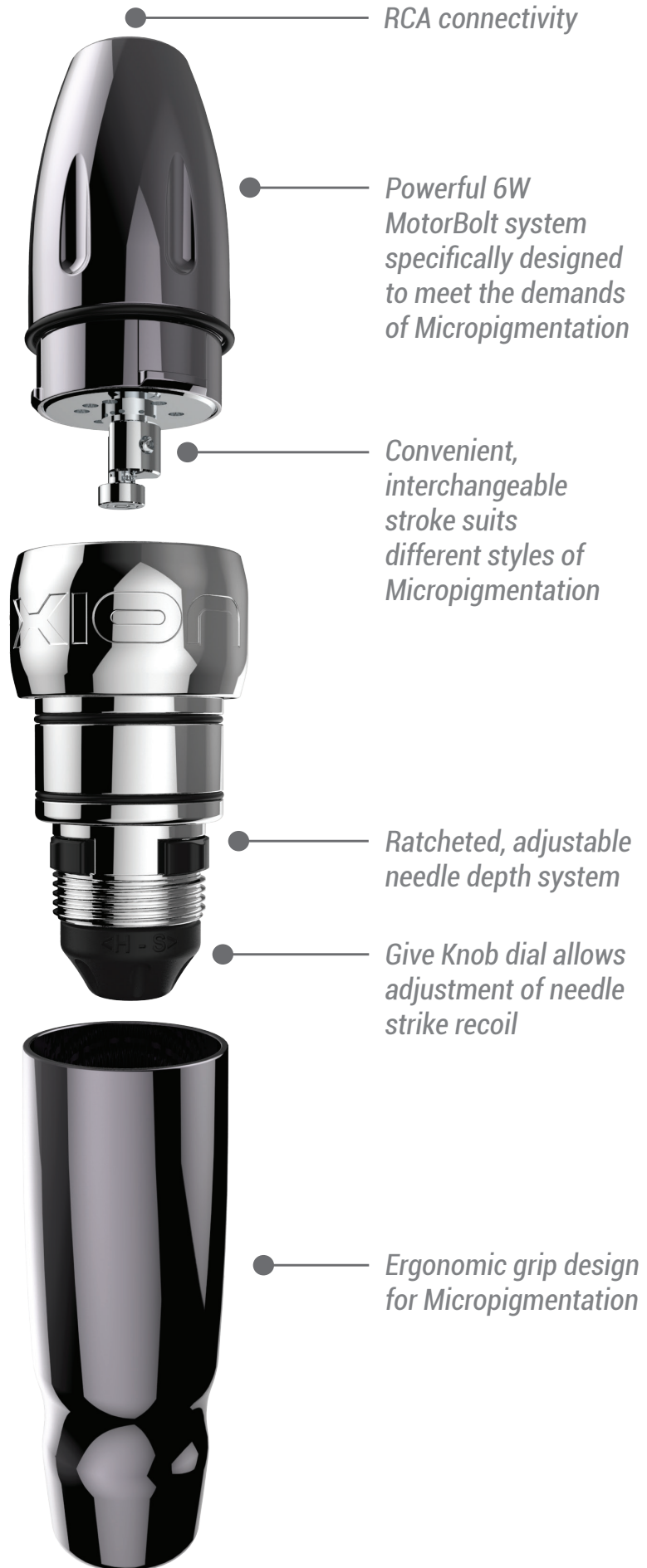

THE GRIP

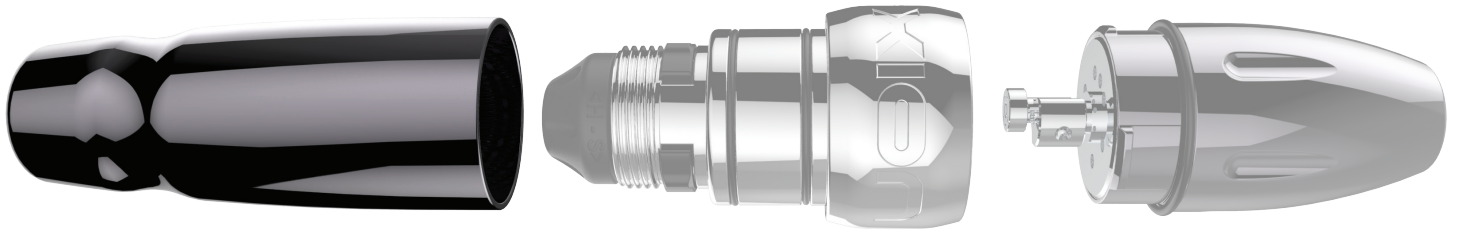

Spektra Xion S Grip



*Autoclavable Ergonomic Grip design*



*Compatible with most membrane needle cartridges on the market*

## THE GRIP

Allowing artists full control of the machine never possible before, the Spektra Xion S offers an ergonomic grip design. The standard Grip

tapers from 26mm to 19mm. Other grip options may be available. The Grip is crafted from a solid rod of 6061 T6 aircraft-grade aluminum. This

polished and anodized grip is safe to be sterilized under steam, in an autoclave or sprayed with cold sanitation solutions.

THE BODY

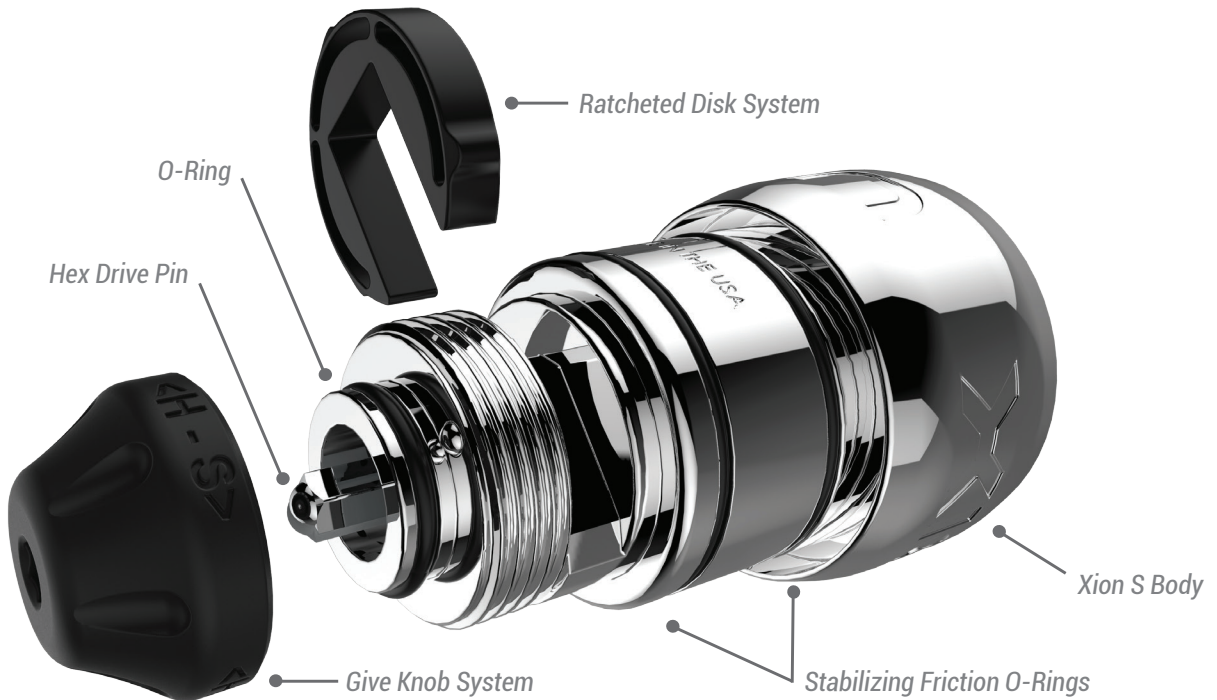

# THE BODY

The Body is the core of the machine where the reciprocating and give system are housed. Constructed from a solid rod of 6061 T6 aircraft-grade aluminum, this module should be sanitized by wiping it with cold sterilization solutions only. **Caution: Do not introduce any types of liquid inside the system.**



Body isometric view



Body posterior view

THE GIVEKNOB

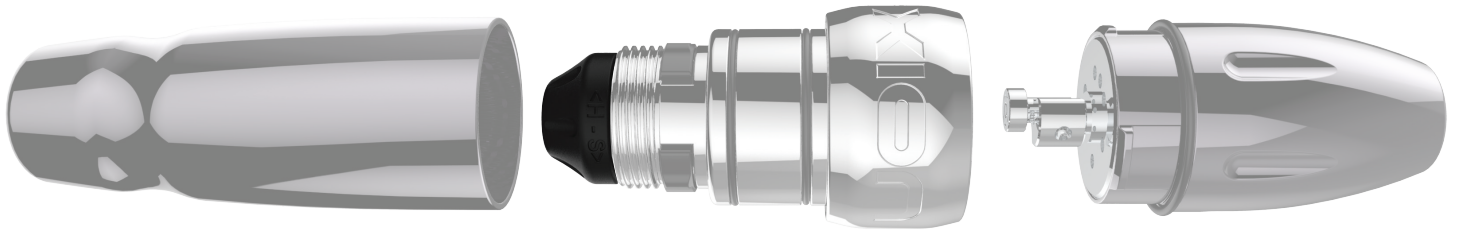

GIVEKNOB

This dial, located at the tip of the body, adjusts your needle strike from hard to soft. Note that this mechanism only spins 270° providing 11 clicks of adjustment. (see page 8 for information on sanitizing).



GiveKnob front view



GiveKnob side view

ADJUST THE GIVE

*Turning the GiveKnob in the arrow's direction decreases the Give*

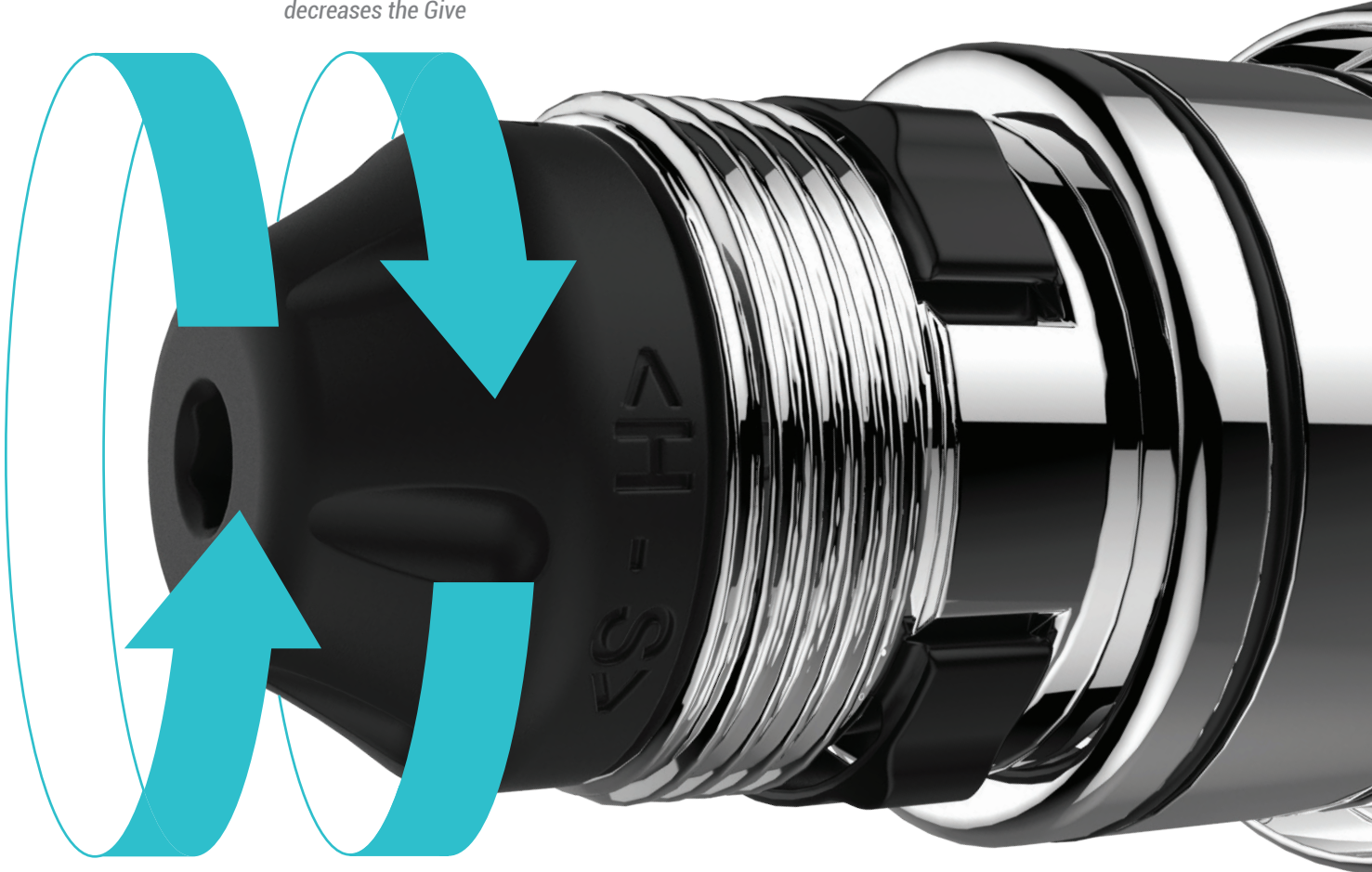

*Turning the GiveKnob in the arrow's direction increases the Give or locks it completely. Always back one click from maximum settings*

## ADJUSTING THE GIVE

**R**emove the Grip by turning counter clockwise until it comes off completely.

An "<H" and ">S" (Hard / Soft) indicates the direction of rotation to achieve a

softer or harder strike.

When adjusting Give, gently press inwards while turning the GiveKnob Dial. This will ensure that you are clicked into a setting and never in between "clicks".

You should always notice a slight radial play once a setting has been selected. Always ensure that you are "clicked-in" to avoid interference between GiveKnob and Hex Drive Pin.



REPLACING THE GIVEKNOB



1

*Use a plastic prying tool, pry gently and pull out GiveKnob*

2

*At this stage you can also sanitize the Hex Drive Pin by wiping it with cold sterilization. Avoid fluids entering the housing*

# HOW TO REMOVE THE GIVEKNOB

To remove the GiveKnob, use a plastic wedge, and carefully insert in between the GiveKnob and Body to gently pry open. **DO NOT use metallic tools!** To replace the GiveKnob,

place it in position ensuring the hex orifice matches the Hex Drive Pin. Apply slight pressure until it clicks into place. Rotate in both directions to ensure proper functionality.

DETACHING THE MOTORBOLT



## DETACHING THE MOTORBOLT

To detach your MotorBolt, ensure you have a firm grip on the Body and Grip. Turn the MotorBolt counter clockwise and pull out.

To attach the motor, push in while ensuring the StrokeWheel is engaged with the internal

element. *Do not apply force until you feel your StrokeWheel has engaged with the internal element.*

If needed, rotate the motor slightly until the stroke finds its course. When this happens, note that the motor is almost

all the way in, topping off with the O-Ring around it and the rim of the body's opening. Before securing the MotorBolt, re-attach by pushing in with pressure and twisting the motor 1/8 of a turn clockwise to lock the MotorBolt.

THE MOTORBOLT SYSTEM

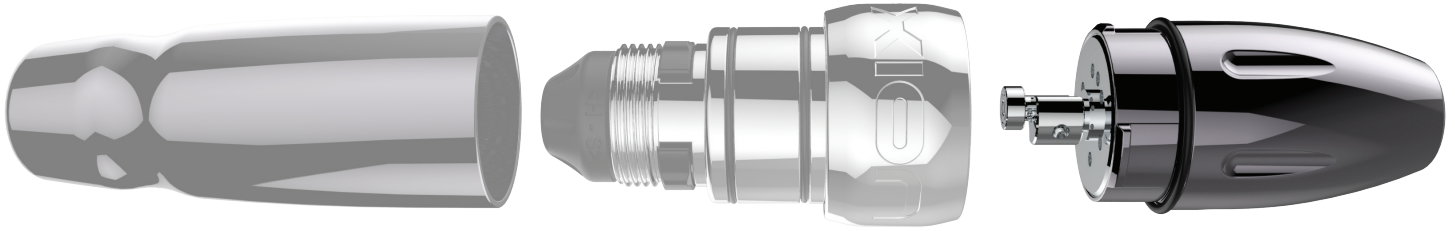

Spektra Xion S Motorbolt system

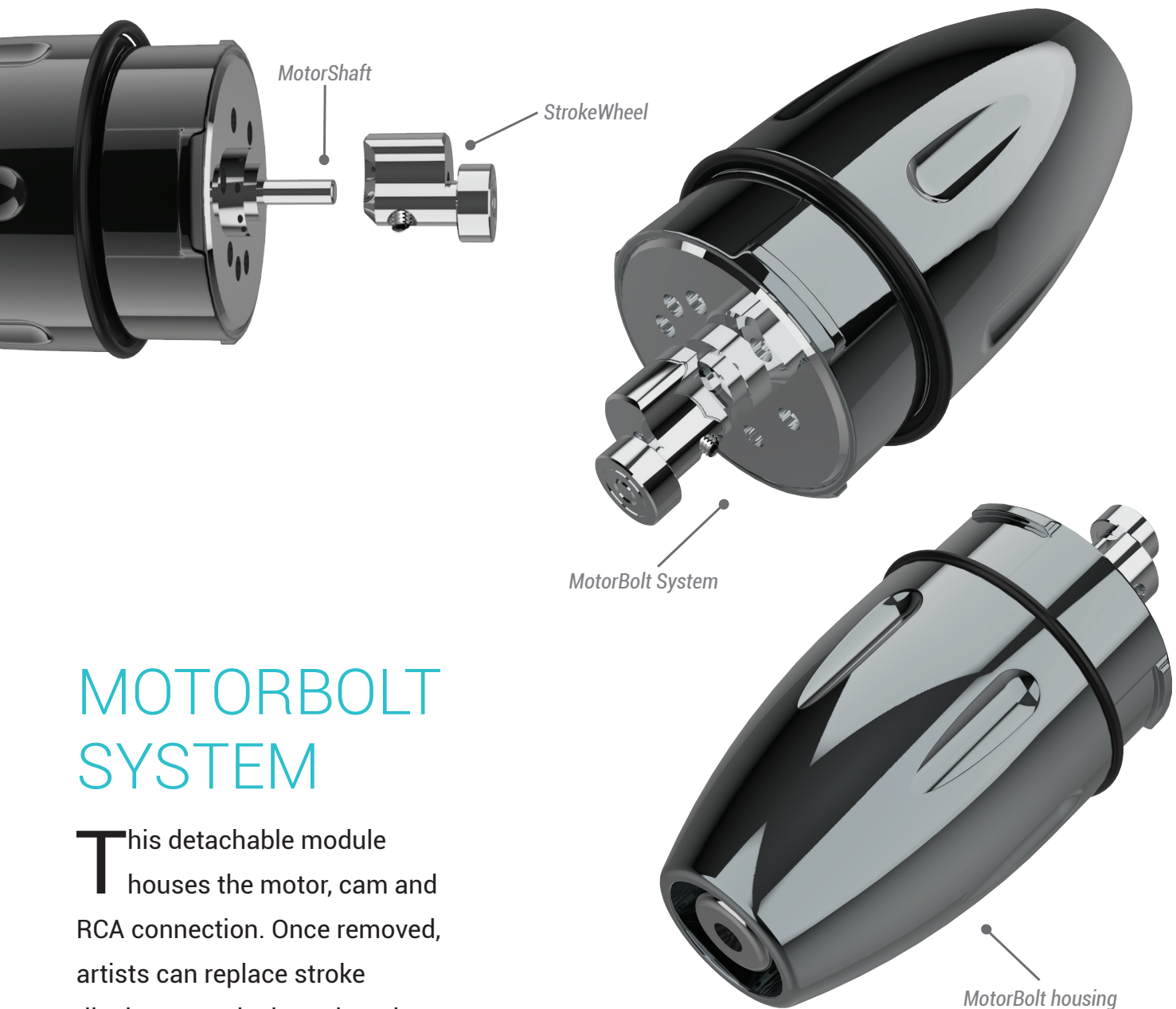

# MOTORBOLT SYSTEM

This detachable module houses the motor, cam and RCA connection. Once removed, artists can replace stroke displacement by interchanging the provided StrokeWheels.

CHANGING THE STROKEWHEEL

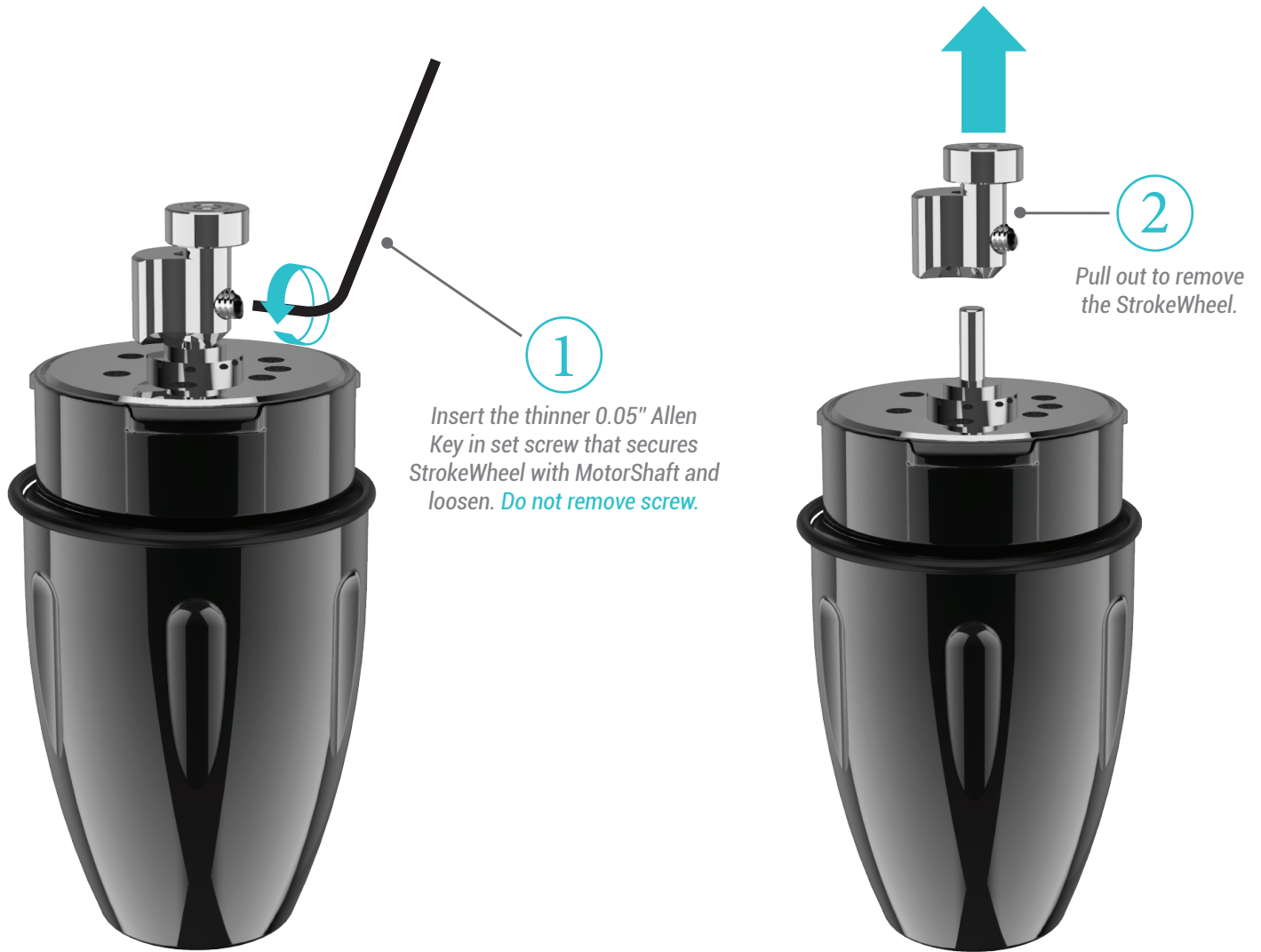

## CHANGING STROKEWHEELS

**R**emove the MotorBolt by pushing in while turning it counter clockwise and pulling out.

**Replacing Stroke:**

Use the tools enclosed in the Xion box:

1-Insert 0.05" Allen Key

in the screw that secures StrokeWheel with MotorShaft and loosen (DO NOT REMOVE). Pull up to remove the StrokeWheel.

2-Locate the spare StrokeWheel located in the box and ensure that the screw

is loosened enough to allow the shaft to slide into the StrokeWheel. Ensure that the StrokeWheel tops off with stop washer located around the shaft. This ensures that the stroke will not collide with internal parts of the body when re-attaching the MotorBolt.

## RCA CONNECTION

RCA  
CONNECTION

**T**his connecting terminal is compatible with most RCA cables on the market. For consistent connection and machine longevity, use of premium RCA cables is recommended.

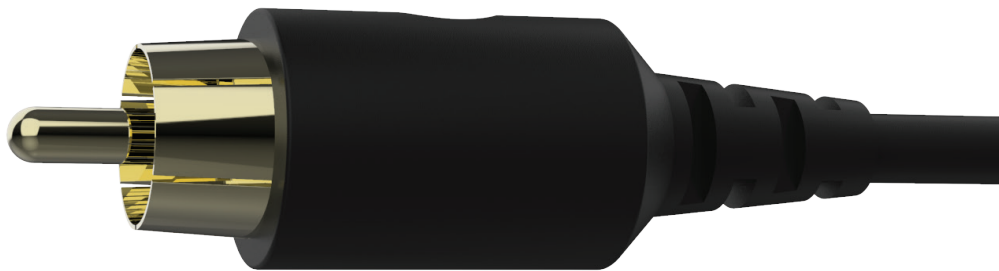

*Gold-Plated Premium Darklab Straight RCA Cord*

CONNECTING YOUR MACHINE



1 Plug the RCA cord into the Xion S RCA connector



Best connection



Improper connection

# HOW TO CONNECT YOUR MACHINE

Insert the RCA into the back of the MotorBolt and connect to a Power Supply. Most of the RCA connector jack is concealed by the MotorBolt housing. Notice that most tattoo power supplies will take 1/4" mono jacks. However, if your

unit uses 1/8" or 3.5mm jack (similar to headphone jacks), you will need to use a reduction from 1/4" female to 3.5 jack or use a cable that goes from male RCA to 3.5mm male jack. Check our website for alternate cable options.

ADJUSTING NEEDLE DEPTH

# ADJUSTING NEEDLE DEPTH

To adjust needle depth, hold the machine body and MotorBolt while turning the Grip. *A counter clockwise turn decreases depth, while a clockwise turn increases depth (also known as needle hang).*

Each time you turn the grip you can feel the tactile feedback of the ratcheting mechanism. Each “click” displaces your needle 0.2mm and allows you to set your needle precisely without involuntarily turning while tattooing.

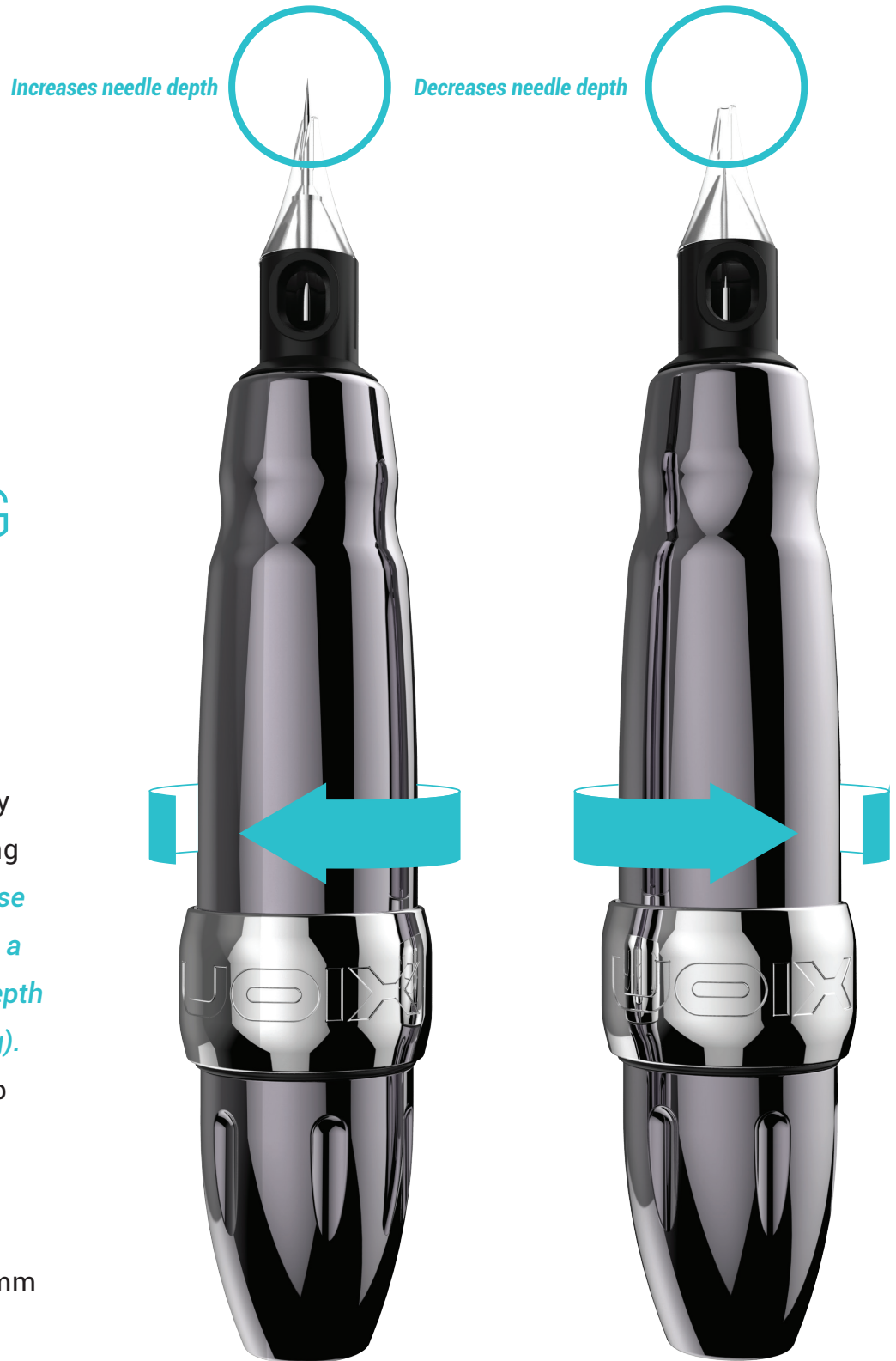

Turning the Grip as the arrow direction show increases needle depth

Turning the Grip as the arrow direction show decreases needle depth

## ADDITIONAL INFORMATION

### VOLTAGE PARAMETERS

While voltage is a parameter that will vary from artist to artist, this machine has been tested to operate at a minimum voltage of around 4 Volts with a maximum voltage of 9.5 Volts.

Depending on the type of needle configuration or brand you use, feel free to adjust the voltage to obtain the desired performance.

*Note: Exceeding 9.5 Volts is not recommended.*

### ACCEPTED NEEDLES

Use cartridge needles with internal membrane. This will avoid accidental contamination inside your machine. Fluids such as ink, water or oil will void warranty of the device and may require replacement of internal parts.

### MAINTENANCE

- Xion is sold pre-lubricated from factory and does not require internal lubrication.
- Prevent any type of external elements from entering inside the machine as they will disrupt the motion of the component and contaminate lubrication.
- The grip of the machine is autoclavable. Use only steam autoclaves at temperatures no higher than 270° Fahrenheit or 132.222° Celsius. Add a hint of ointment or PTFE grease around internal opening of grip or on stabilizing friction O-rings for optimal functionality after autoclaving. Refer to page 5 for additional information.
- Machine Body and MotorBolt can be sanitized from the outside with cold sterilization products.
- Never spray the surface directly to prevent fluids from entering the machine. Always use pads or disposable paper towels to apply sterilization products.
- The mechanism relies on a return spring. **DO NOT DISASSEMBLE MACHINE.**

### WARRANTY

- All the housing components (Grip, Machine Body and Motor Housing) are covered by a lifetime warranty.
- Internal parts are subject to wear and the motor itself will be covered by a 1 year warranty from the date of purchase.
- Motor warranty is void if motor shows signs of being dropped, internal fluids enter the motor and/or motor shows signs of being tampered with in any way.



## ADDITIONAL INFORMATION

### HANDY TIPS

The following tips will help you get the most out of your Spektra Xion and avoid potential issues:

- Always secure your machine. Dropping the machine can cause damage to the magnets, bearings and brushes of the motor.
- Use only cartridges with membranes to avoid contamination.
- Do not exceed the suggested voltage.
- Always use power supplies with at least 1Amp of current supply.
- Rinse your needle frequently to avoid pigment drying up and slowing down your cartridges. When rinsing your needle, ensure to dip only the tip of the cartridge to avoid back flow of fluids.
- Inspect your needles prior to use.
- Use only quality cables. A good connection will ensure consistent performance.
- Avoid scratching the surface of the embodiments.
- Use only FDA-approved cold sterilization solutions for disinfection.
- Do not lubricate machine unless instructed otherwise.
- Store your machine in a secure place.

### TROUBLESHOOTING

#### 1.- Machine manufacturer

FK Irons: 1771 NW 79th Avenue, Doral, Florida 33126

#### 2.- Servicing your machine

Just like any mechanical device subject to use, FK Irons strongly suggests that you service your product at least once a year to ensure that a proper diagnosis of all working parts is conducted. This ensures the optimal condition of all working parts including internal machine clean up and fresh lubrication. Routine servicing will ensure that your machine remains functioning like the very first day. Service is subject to fees.

#### 3.- Warning

Disconnect machine from any power before making any adjustments.

For service inquiries, please contact [service@fkirons.com](mailto:service@fkirons.com).

For additional tips and tutorials, please visit [Youtube.com/fkirons](https://www.youtube.com/fkirons)